



HEALTHCARE

Energy Distribution Solutions and Lighting Systems



HEALTHCARE

Please visit our website for the updated version of our catalogues.
www.eaegroup.com



CONTENTS

▶▶ HEALTHCARE

Group Profile	2
EAE Because	3
Why EAE.....	4-9
EAE Products.....	10-11
EAE Busbar Products.....	12-15
Advantages	16
EAE Cable Management.....	17-19
EAE Support Products.....	20
EAE Fit-out Products	21-23
EAE Lighting Solutions	24-25
EAE Electrotechnical Product	26
EAE Lighting Automation.....	27
Major References List	28-30



**EAE Headquarters & Plant 1 Busbar Factory
Istanbul / TURKEY**



**Plant 2 Cable Tray Factory
Kocaeli / TURKEY**



**Plant 3 Technology Factory
Istanbul / TURKEY**



**Plant 4 Busbar Factory
Kocaeli / TURKEY**



**Plant 5 Busbar & Lighting Factory
Aleksandrov / RUSSIA**



**Plant 6 LED Lighting Fixture Factory
Kocaeli / TURKEY**

Founded in 1973, EAE Elektrik A.S. is a subsidiary of EAE Group - one of the largest manufacturers in Turkish electrical industry and is a worldwide check of electrical products.

EAE Group has around 2000 employees and 6 manufacturing facilities, with a covered manufacturing area of 270.000 m². It operates in more than 100 countries with sales and marketing offices located in 14 countries. EAE Elektrik A.S. is one of the largest busbar, manufacturers globally. EAE holds ISO 9001, ISO 27001, ISO 14001 and ISO 18001. Factories in the new compound has Leed Gold certification.

EAE Elektrik A.S. busbar products are certified by KEMA/DEKRA (Holland), KEMA – KEUR, UL classified laboratories as per IEC 61439-1/6 standards. EAE also has local certifications for specific marker.

EAE's corporate vision is "Think Lean, Live Lean" as it passionately nurtures its global growth story with greener production, better utilization of natural resources and more sustainable business processes.

EAE products are approved and sold by dealers / distributors regional and partners all around the world.



**FOUNDED
1973**



**7
FACILITIES**



**360.000 m²
COVERED AREA**



**SALES IN 150+
COUNTRIES**



**3 R&D
DEPARTMENTS**

HEALTHCARE

EAE Because...



High Standards



Wide Range of Products



Optimum Price



Continuous Innovation



Wide Services and Solutions



▶▶ GREEN GUARD CERTIFICATE

- The chemical pollutants come from products and materials that we use at our homes and workspaces like furniture, equipments and building materials. These materials emit Volatile Organic Compounds (VOCs) that can negatively affect our health. Since our heating and cooling systems recirculate the same air in all the rooms, that means that VOCs remain inside the buildings, posing problems.
- The Greenguard Environmental Institute is an independent organization that certifies products and materials for low chemical emissions. Products that are certified by Greenguard have to meet stringent standards and emission limits for indoor use like schools, daycares and other areas. You can rest assured that any product with the Greenguard Gold certification will not emit significant chemical compounds into the air which is scientifically proven to reduce indoor air pollution and the risk of chemical exposure,
- EAE power Busbar systems are certified by Greenguard since 2015.



GREEN GUARD



▶▶ FIRE RESISTANCE CERTIFICATE

- **Fire Resistance Tests IEC 60331-1**
(Circuit Integrity Under Fire for E-LINE KX)
 - IEC 60331-1 1000°C-3 Hours - BRE, UK
 - IEC 60331-1 950°C-3 Hours - TUV, Singapore
 - IEC 60331-1 1000°C-2 Hours - DEKRA, Holland
 - BS 8491 842°C-2 Hours - BRE, UK (Sprinkler Water+Mechanical Impact)
 - EN 50399 Low Heat and Low Smoke Release B1/S1 d0 - Dekra, Holland
- **Fire Resistance & Circuit Integrity Tests for E-Line KX with Plug in Tap Off Box**
 - IEC 60331-1 830 C - over 3 hours, Magnetic MCCB - DEKRA, Holland
 - IEC 60331-1 830 C - over 3 hours, NH Fuses - DEKRA, Holland
- **Flame Propagation Test IEC 60332-3 (IEC 61439-6,10.101)**
- **Fire Barrier Test - 2 Hours ISO 834-1 (IEC 61439-6,10.102)**



▶▶ SEISMIC SUPPORTS

- EAE Seismic support systems offer perfect solutions of installations for earthquake protection.
- Seismic supports which can be applied on all kinds of installations ensure easy and quick mounting. Thanks to the accessories designed for steel-beam and space frame connections.



▶▶ RoHS & REACH

- RoHS directives were published and started to implement from 01 July 2006 to all members of this protocol worldwide. This directive's goal is to limit some hazardous materials like Pb, Hg, Cd in Electrical and Electronic equipments. Those materials had a serious impact on human health.
- EAE ELEKTRİK keeps the human health and product safety at the highest level to not use of detrimental elements that create negative effects on the environment and human health, as stated in the RoHS directives.
- This is confirmed by the RoHS certificate by having the components used in the products manufactured are tested separately.



▶▶HYGIENIC ENVIRONMENT

- EAE ELEKTRIK can manufacture the special Busbar systems for Hygienic environment in stainless steel metal or polyester epoxy painted housing to ensure the requirement.
- EAE also has stainless steel cable trays in many sizes and types that can be safely used wherever needed.
- Floor boxes too can be manufactured with stainless steel cover and frames.



▶▶PAINTED HOUSING FOR BUSBAR SYSTEM (ANY COLOR)

- Housing of any type/model/rating Busbar can be painted in any color selected by designer/client in order to match the building/room aesthetically.
- Polyester epoxy paint with min. 75 micron thickness on the housing provides a better strength against environmental conditions.
- Similar requirement can be applied to our Cable trays as well.
- This process is done in EAE's inhouse plant as per QA/QS procedures in several steps with a chemical surface preparation, acidic treatments for degreasing and applying the necessary coats of paint on the surface of metal sheets.

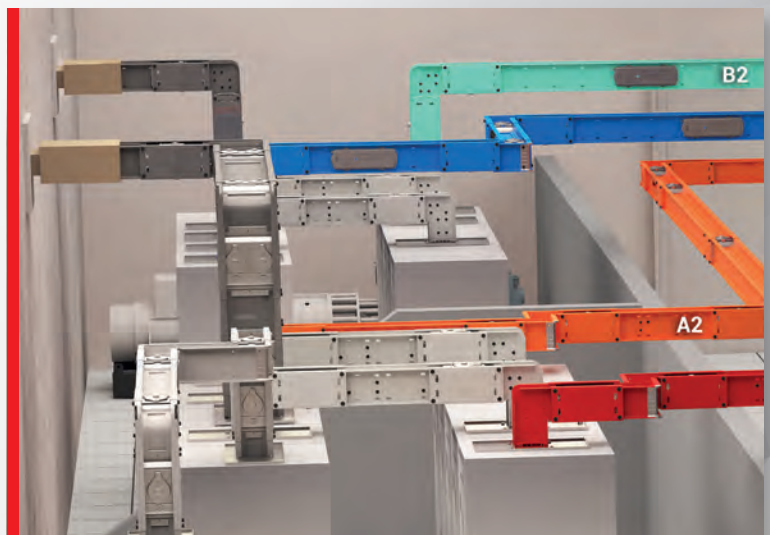

▶▶ EMC & EMI

- Conductive materials form magnetic field when electric current flowing is through them. Magnetic field is related to magnitude of current, distance between conductors and conductor body.
- In cases where low EMC values are mandatory (health centers, offices, data centers etc.), it is very important to minimize the magnetic induction value.
- Busbar systems with their aluminum or sheet metal bodies, compact structures and the configuration of the conductors in housing help significantly reduce the electromagnetic fields formed.
- Complete range of EAE Busbar products are tested for EMC certificates. EMC measurements made on custom designed EAE Busbar systems showed that using aluminium housing decreases the EMC and potential hazard levels.

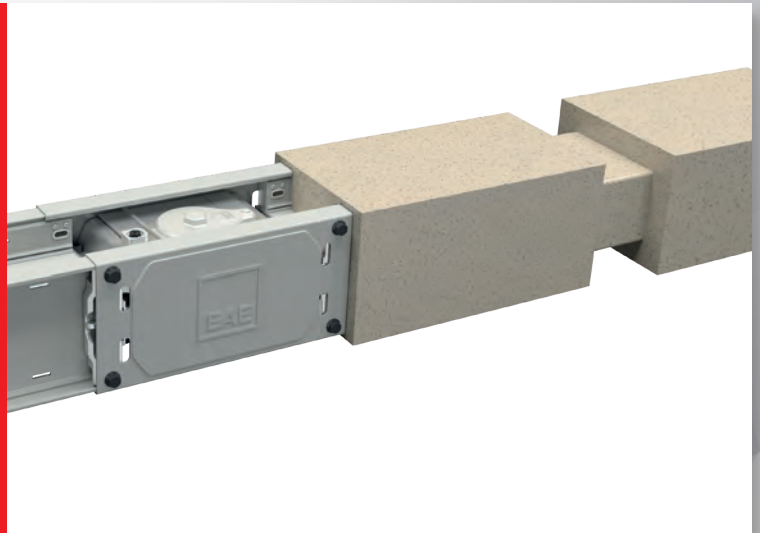

▶▶ STAINLESS STEEL CABLE TRAYS & BUSBARS

- EAE manufactures special Busbar systems for Hygienic environment in stainless steel or polyester epoxy painted housing to ensure the requirement.
- Similarly EAE has stainless steel cable trays in many size and types that can be safely used wherever needed.
- Floor boxes also can be manufactured with stainless steel cover and frames.

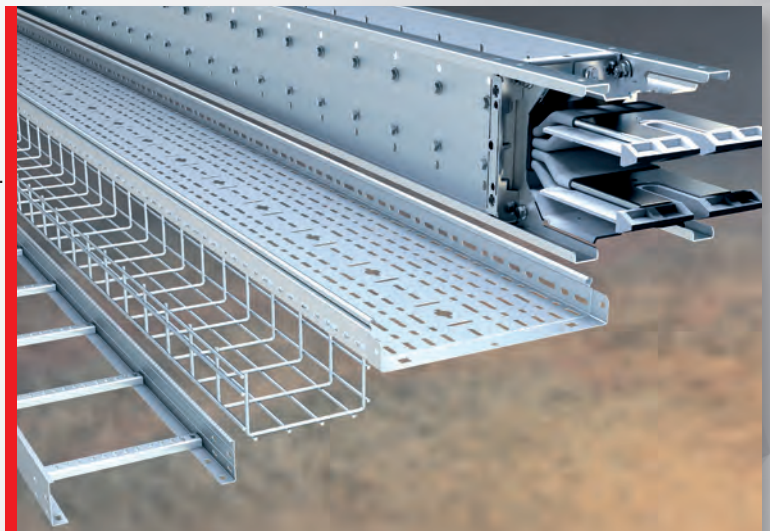

▶▶ LABORATORY ROOMS

- E-LINE FL Indoor Busbar Trunking Systems can be mounted on any structure or surface using brackets. They can be used separately for power or UPS sockets requirements when needed. Power and UPS sockets with aesthetic design and different color options can be installed without any hand tools at desired point.
- E-LINE FL BUSBAR is produced in accordance with ISO 9001 standards with a certified quality management system using the world's latest manufacturing technologies. Units are designed and tested according to IEC 61439-6, IEC 61534-1 and IEC 60884-1.
- The phase conductor structure is protected against finger contact and dust using a screen system along the length of the busbar. In cases where the socket is live the socket is secured into position using a special locking system. Sockets do not come off, thanks to the clamping structure.



▶▶ TAP-OFF BOX W/ ANY TYPE OF BREAKERS

Bolt-on tap off is a unique technology to draw power up to 1000 A at block joints providing flexible solution.

EAE tap off boxes are compatible with World wide brands of circuit breakers and switches.

All metal enclosure tap-off boxes can be supplied;

- With any type, model, brand of breakers
- With any gland type or with a blank gland plate
- Any required colour of housing
- Has an electrical interlock mechanism
- Has a mechanical interlock mechanism
- Has IP55 protection degree
- Has tulip contacts made of silver plated copper
- Can be tailor made to any size

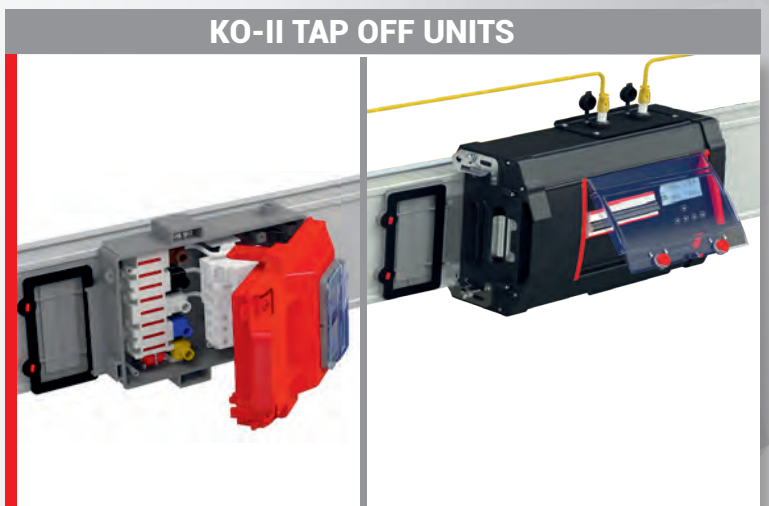

►► UNDERFLOOR UNITS

- **Smart:** Off-the-shelf products ready for use and equipped with power (mains/ ups), data, telephone and multimedia sockets for desk jobs, meetings and presentations.
- Raw material used in all plastic parts in our products is polycarbonate (PC) and is halogen free and is within V0 flame retardant class according to UL 94 standard.
- Product selections with optional exclusively designed box equipped with Miniature Circuit Breaker (MCB), Residual Current Device (RCD) or Residual Current Circuit Breaker with Over Current Protection (RCBO).
- **Cable Organizer:** To connect strong current, weak current and multimedia cables from the flooring to the desks or work environments.
- **Grommet:** With its small and compact structure, it can be used as a 6 modules socket box. Besides if required, with suitable MCB, RCB or RCBO plate, it can be used for cable outlet from ground to table. Gasket shielded window that enables comfortable and secure outlet with multiple cables.



►► CABLE TRAYS AND FIRE RESISTANT SUPPORT SYSTEMS



HEALTHCARE

EAE Products

▶▶ EAE Product Types

- Busbar Power Distribution Systems
- Trolley Busbar Systems
- Fit-out Solutions
- Cable Management Systems
- Lighting Solutions
- Panel Enclosures, Distribution Boxes
- Lighting Automation

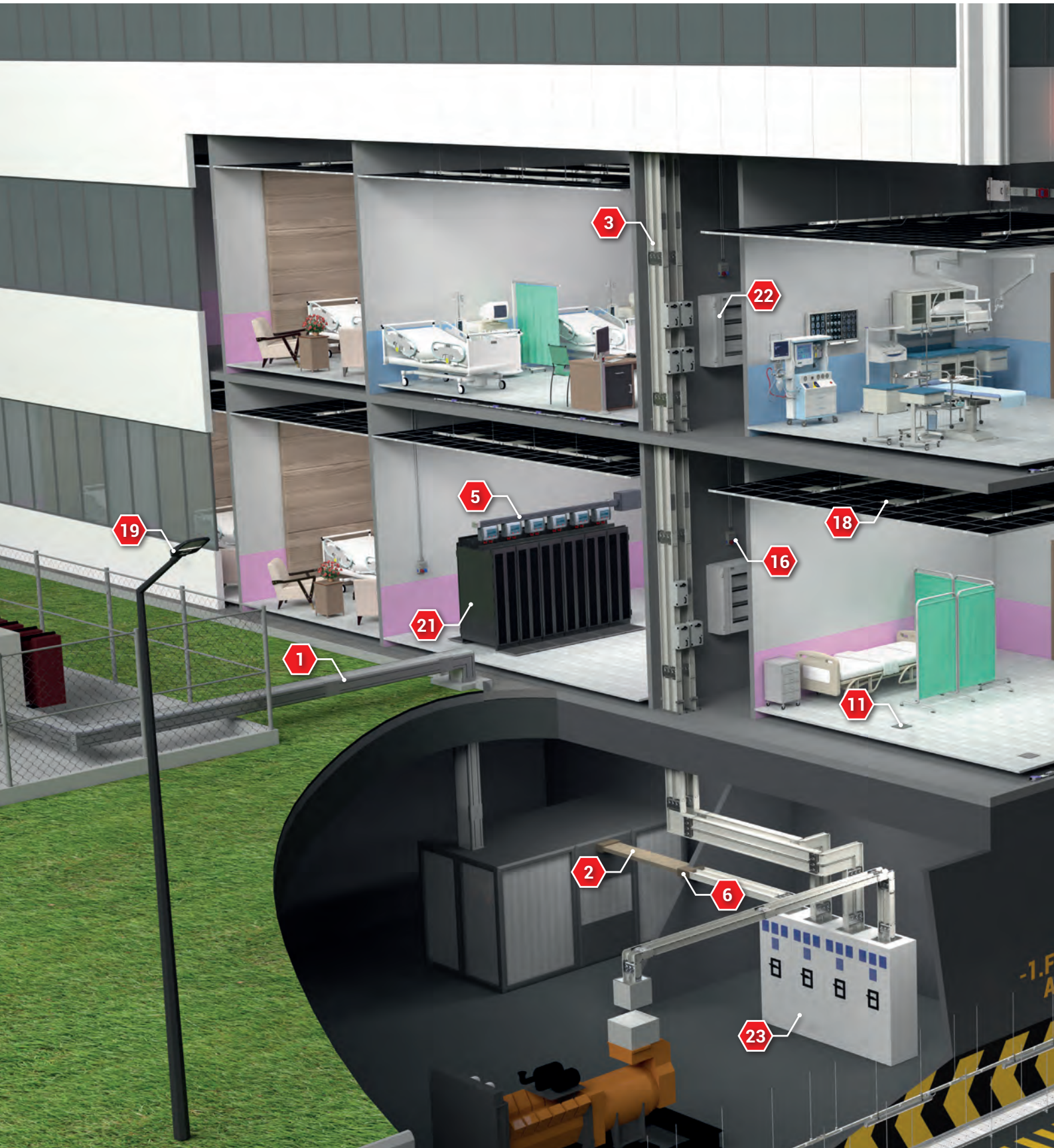



- **Busbar Power Distribution Systems**
 - 1- E-LINE MV - Medium Voltage Busbar Systems
 - 2- E-LINE CR - Cast Resin Busbar Systems
 - 3- E-LINE KX - Compact Busbar Systems
 - 4- E-LINE KO-II - Busbar Systems
 - 5- E-LINE KD - Data Rack Busbar Systems
 - 6- E-LINE CR/KX - Busbar Transition Module
 - 7- E-LINE DL/SL - Multi-conductor Lighting Busbar Systems
- **Cable Management Systems**
 - 8- E-LINE UK - Cable Tray Systems
 - 9- E-LINE A-A - Support Systems
- **Fit-out Solutions**
 - 10- DABLINE - Raised Floor Power Systems
 - 11- E-LINE N-DK - Underfloor and Raised Floor Solutions
 - 12- E-LINE SMART IN-I - Multi-outlet Extension Blocks
 - 13- E-LINE SMART DEC6 - Multi-outlet Extension Blocks
 - 14- E-LINE SMART DEC7 - Multi-outlet Extension Blocks
 - 15- E-LINE MINI - Mini Series Pop-up and IP66 Outlet Boxes
 - 16- E-LINE E-BOX - Socket Combination Box
 - 17- E-LINE KM - Multi-conductor Lighting Busbar Systems
- **Lighting Solutions**
 - 18- BLOOM IP65 - Lighting Solutions
 - 19- RA - Outdoor Lighting Systems
 - 20- LINE ETANJ - Lighting Solutions
- **Panel Enclosures, Distribution Boxes**
 - 21- KABIN PLUS - Data Center Rack Cabinets
 - 22- E-KABIN - Cabinets
 - 23- Panel Master - Cabinets

▶▶ E-LINE MV

Medium Voltage Busbar Distribution System 950...5000A

Overview

The E-Line MV Series Busbar Systems, as the newest addition to the busbar product range, is offered with 12 kV and 17,5 kV variants. It offers safe and efficient power transmission. MV CR is manufactured in a single body with Cu conductors embedded in DURACOMP insulation which is a composite material of epoxy and pure silicon.



Features:

- 12 kV and 17,5 kV variants
- DURACOMP composite body
- Ex-proof
- IP68 protection degree
- Cu conductor
- 3 conductors

▶▶ E-LINE CR

Compact Busbar Distribution System 630...6300 A

Overview

The body of the E-Line CR busbar is formed using DURACOMP, a composite material of epoxy resin and pure silicon which gives protection against arduous environments and high impact.

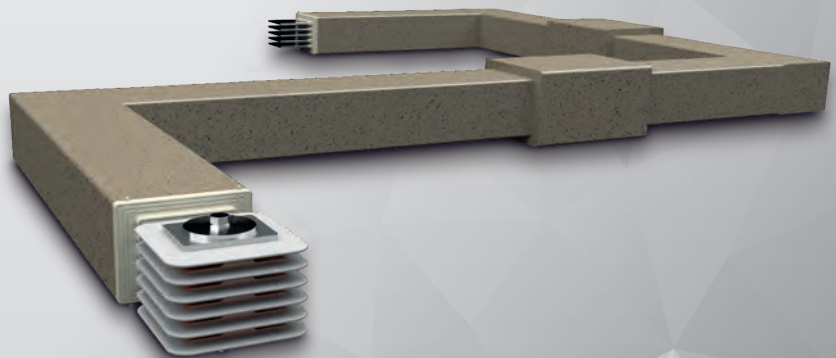

Features:

- Current Aluminium and Copper ranges from 630A to 6300A
- IP68 / IP69 K protection degree
- 4, 5 and 6 conductor options
- Clean earth option
- IEC 60331-1, 3 hours of continuous current under fire condition
- Conformance to seismic requirements in accordance with IEC 60068-3-3; IEC 60068- 2-57 and IEEE 693 standards

▶▶ E-LINE KX

Compact Busbar Distribution System 400...6300 A

Overview

The EAE E-Line KX Series compact busbar system is designed for use in projects requiring high power distribution, and is rated from 400A to 6300A using the latest technology.



Features:

- Modular structure
- Ability to supply energy either from the joints or from the tap-off points (Bolt-on or Plug-in)
- High electrical and mechanical strength
- Fast, easy and reliable installation with single bolt joint construction.
- Output units allow a significant saving about panel and system cost
- Special design for minimal voltage drop
- Tin plated (optional silver plated) aluminium or copper conductors
- IP 55 and IP 65 standard, IP 67 optional protection degree
- Aluminium housing
- Epoxy insulation
- Fire resistance as per IEC 60331
- UL and IEC product

▶▶ E-LINE CCR

Compact Busbar Distribution System 850...6300 A

Overview

The body of the E-Line CCR busbar is formed using DURACOMP, a composite material of epoxy resin and pure silicon with Aluminium housing body which gives protection against arduous environments and high impact.



Features:

- Current Aluminium and Copper ranges from 850A to 6300A
- IP68 / IP69 K protection degree
- 4 and 5 conductor options
- Clean earth option
- IEC 60331-1, 3 hours of continuous current under fire condition
- Conformance to seismic requirements in accordance with IEC 60068-3-3; IEC 60068-2-57 and IEEE 693 standards

▶▶ E-LINE KO-II

Busbar Distribution System 160...800A

Overview

"E-Line KO Series" medium range busbar systems provide suitable solutions for electricity transmission and distribution in medium-sized project facilities.



Features:

- Modular structure
- Plug-in tap off outlets at every 25 cm
- Aluminium or copper conductors
- 4, 4,5 or 5 conductors
- Tin plated conductors
- Dust cover on outlet points
- IP 55 protection class

▶▶ E-LINE KD

Data Rack Busbar Systems 160...800A

Overview

To power the mission critical IT infrastructures, EAE offers a highly flexible Busbar Systems for reliable and energy efficient operations in your Healthcare System's Data Centers.

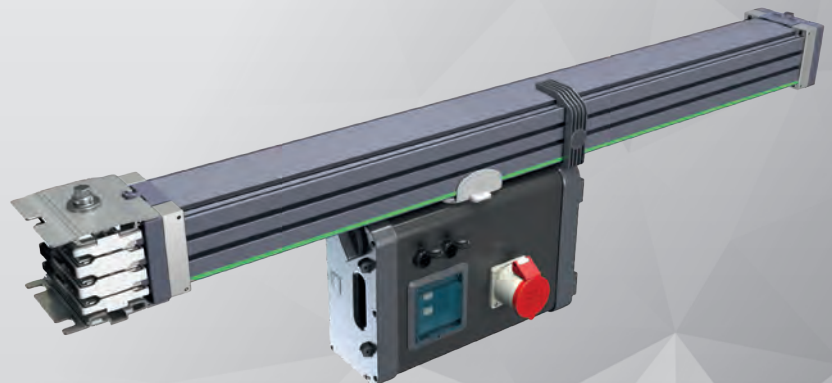

Features:

- Plug-n-play anywhere along the bar
- Protected Tap-Off Contacts
- Tap-Off contacts with heat cycle testing
- Al and Cu conductor options
- Safe Alignment mechanism ensures correct installation and operation
- Special interlock mechanism enabling to carry the weight of the plug-in box and cables by the busbar housing
- Up to 6 conductor option
- IP23D protection

▶▶ E-LINE MK

Busbar Distribution System 100-160-225-250A

Overview

The small power range busbar systems of "E-Line MK Series" provide flexible and cost-effective solutions for the transmission and distribution of electricity in small-sized enterprises, workshops and industrial facilities.



Features:

- Modular structure
- Plug-in tap off outlets at every 25 cm on both side
- Tin plated aluminium or copper conductors
- 4 or 5 conductors
- Hinged and lockable dust cover on outlet points
- Installation without using a torque wrench (shearhead bolts)
- IP 55 protection class
- Flexible elbows and expansion modules

▶▶ E-LINE DL/SL

Multi-conductor Lighting Busbar Systems 25-32-40A

Overview

The E-Line DL/SL range of busbar systems are used in buildings on lighting and socket circuits where 25A, 32A or 40A Three-phase or Single-phase power is required. 10-16A plugs or 25A tap-off boxes with a cartridge fuse or miniature circuit breaker are specially designed to supply lighting and power circuits as per the specifications.

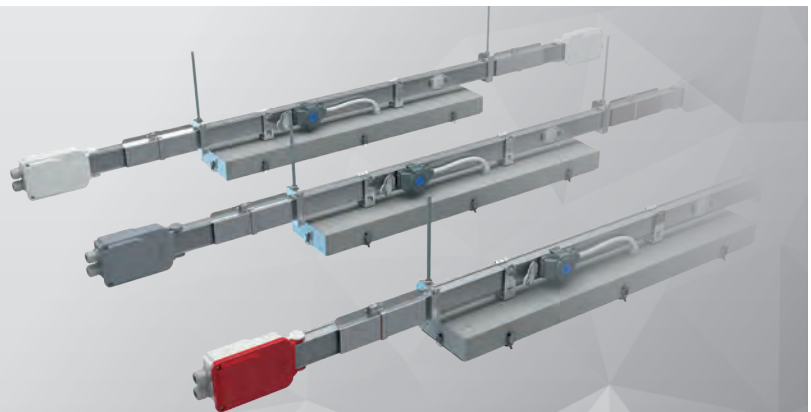

Features:

- Choice of conductor configurations up to 10 conductors with 5+5 form
- Tap-off plugs are available in different colours to indicate the phases
- Strong body structure which can support all types of luminaires
- IP 55 protection class
- Clean Earth "CE" conductor for UPS circuit
- The Emergency Kit (ACK) supply and the Dali signal are fed through the same busbar and tap off plug negating the need for extra cabling.

HEALTHCARE

EAE Busbar Advantages



Electrical power distribution is vital for any building. The distribution products need to be selected carefully in order to obtain the safest, reliable and long lasting system

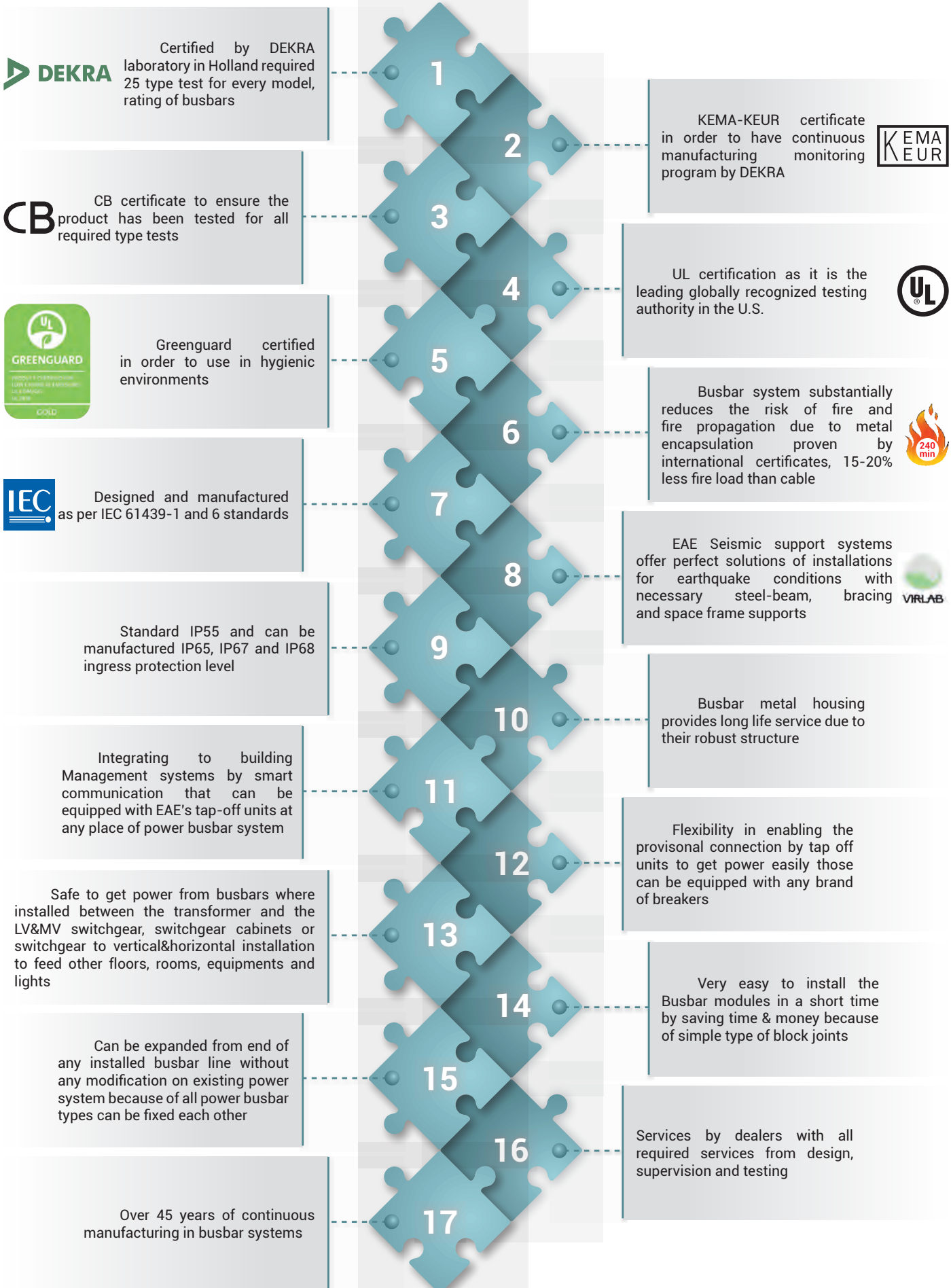

▶▶ E-LINE CT

Hot-dip Galvanized Cable Tray Systems

Overview

E-Line CT series hot-dip galvanized cable trays are designed to carry the cabling in indoor or outdoor installations internally or externally in factories and buildings, especially in humid or vaporous environments. They can also be manufactured as pre-galvanized upon request.

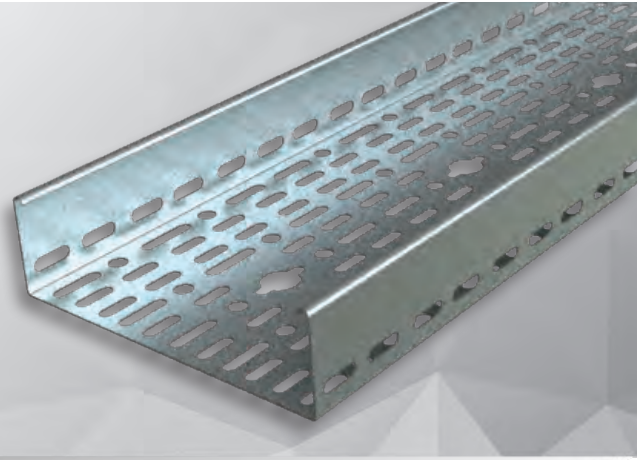

Features:

- Heavy duty and regular types
- 40/50/60/75/100/125/150mm tray heights
- 50/100/150/200/250/300/400/500/600 widths (700-800-900 special widths on request)
- 0,8/1/1,2/1,5/2mm thickness
- 3000mm length (6000mm special length on request)
- TS EN ISO 1461 standard hot-dip and after special EAE protective coating over hot dip
- Possibility to connect the various accessories that 20,5 diametres hole in the middle of the tray
- Wide range of accessories
- Fire resistance certificates (E30-E60-E90)
- Galvanized steel painted finish available on request (epoxy, epoxy polyester, polyester)

▶▶ E-LINE KME

Hot-dip Galvanized Cable Ladders

Overview

E-Line KME cable ladders are designed to route the cabling in facilities and buildings in internal or external environments on vertical shafts thanks to its high load bearing capacity.

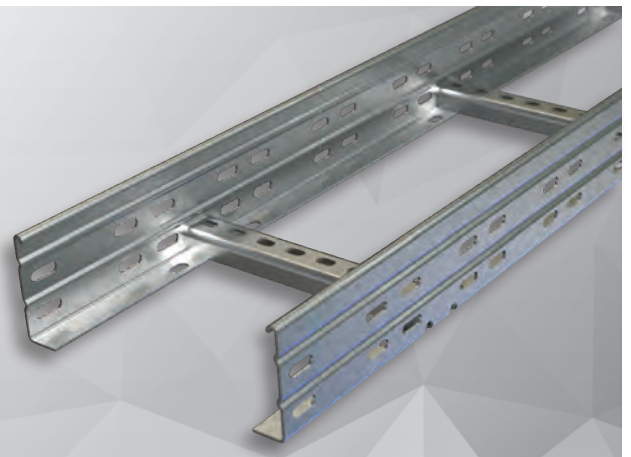

Features:

- Heavy duty type
- 40/50/60/75/100/125/150mm heights
- 50/100/150/200/250/300/400/500/600mm widths
- With Binrak traverse with 700/800/900 width options, high bearing capacity (KME)
- 1,2/1,5/2mm thickness
- Load carrying capacity can be increased by giving shape to the sheet iron.
- 300mm equally spaced traverse structure
- TS EN ISO 1461 standard hot-dip production
- Wide range of accessories
- Fire resistance certificates (E30-E60-E90)
- Galvanized steel painted finish available on request (epoxy, epoxy polyester, polyester)

▶▶ E-LINE UKE

Cable Tray Systems

Overview

The E-Line UKE series pre-galvanized cable trays are produced in a standard heavy-duty type according to TSE (Turkish Standards Institution), TS EN 10346, and ISO 10143 standards. Manufactured through the "Roll Forming" method, they are produced as a single piece up to a length of 6m. The standard length is 3m. They are designed to carry cable installations in internal environments within facilities and buildings.

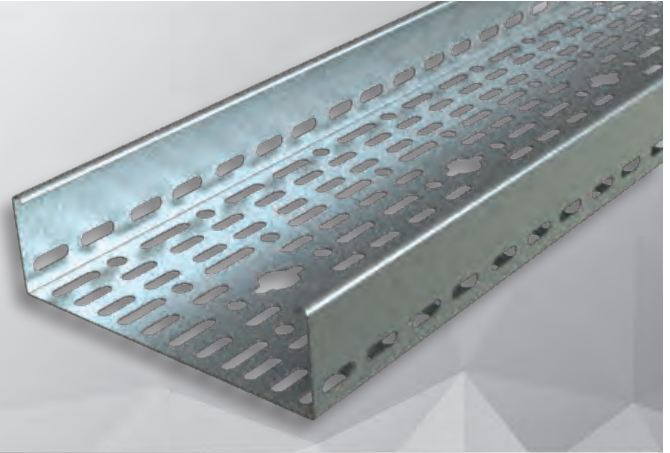

Features:

- Heavy duty type
- Standard 40/50/60/75/100mm heights produced
- 50/100/150/200/250/300/400/500/600mm widths
- 0,8/1/1,2/1,5/2mm thickness
- 3000/4000/5000/6000mm lengths
- According to the TS EN 10346 and TS EN 10143 standards galvanized option (pregalvanized)
- Possibility to connect the various accessories that 20,5 diametres hole in the middle of the tray
- Wide range of accessories
- Fire resistance certificates (E30-E60-E90)
- Galvanized steel painted finish available on request (epoxy, epoxy polyester, polyester)

▶▶ E-LINE CTK

Hot-dip Snap On Covered Cable Duct Systems

Overview

E-Line CTK series hot dip snap on cover cable tray systems can be easily mounted without the need for cover fixings thanks to the special bends on the cover and the tray.



Features:

- Heavy duty type
- 60 / 75 / 100mm heights
- Thickness: 1.5mm for 100/150/200/250/300mm 2mm for 400/500/600mm
- 3000mm length (6000mm special length on request.)
- Plug cover structure
- TS EN ISO 1461 standard hot-dip and after special EAE protective coating over hot dip
- Possibility to connect the various accessories that 20,5 diametres hole in the middle of the tray (Allows fast mounting for devices such as lighting panel, fire detector etc.)
- Wide range of accessories
- Fire resistance certificates (E30-E60-E90)
- Galvanized steel painted finish available on request (epoxy, epoxy polyester, polyester.)

▶▶ E-LINE TKS Trunking Systems

Overview

E-Line TKS series trunking cover cable trays systems are used for cabling in indoor environments. They are manufactured as pre-galvanized or Hot dip. The cover is easily mounted thanks to the special lock system. Mounting the modules on trays is quick and simple.

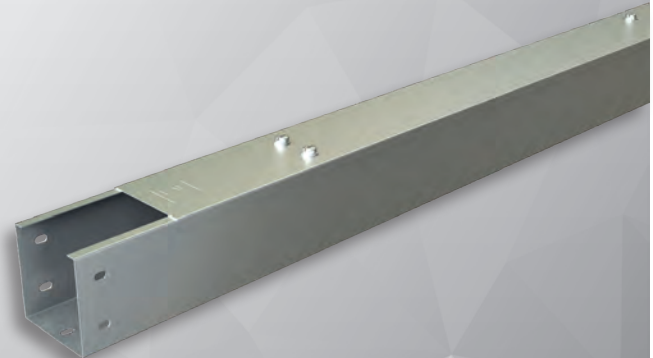

Features:

- Heavy duty type
- 3000mm Standard length
- Standard 50/75/100/150mm Available height size
- 50/75/100/150/200mm Available width size
- 1,2/1,5mm Thickness
- TS EN 50085, TS EN 10346, TS EN 10143 and TS EN 1461 standards

▶▶ E-LINE TLS Wire Mesh Cable Trays

Overview

E-line TLS series wire mesh cable trays allows for downward outputs and to the right or left between the wires to be easily made thanks to the cage structure of wire mesh tray systems. Products are produced as stainless steel or electro-galvanized plated options.



Features:

- Heavy duty type
- 3000mm Standard length
- Standard 35/55/75/85/100mm Available height size
- 50/100/150/200/250/300/400/500/600mm Available width size
- 4/5mm Thickness
- TS EN 61537, TS 149 and AISI 304 (SS) standards

▶▶ E-LINE A-A

Support - Accessories Systems

Overview

E-LINE A-A series and E-Line Seismic suspension systems are used in buildings and factories; in concrete or steel structures to carry Busbar, Conduit, Cable Ladder, etc. Systems appropriately. Service- and light service-type suspension types diversities are available according to the weight of the system to be carried.

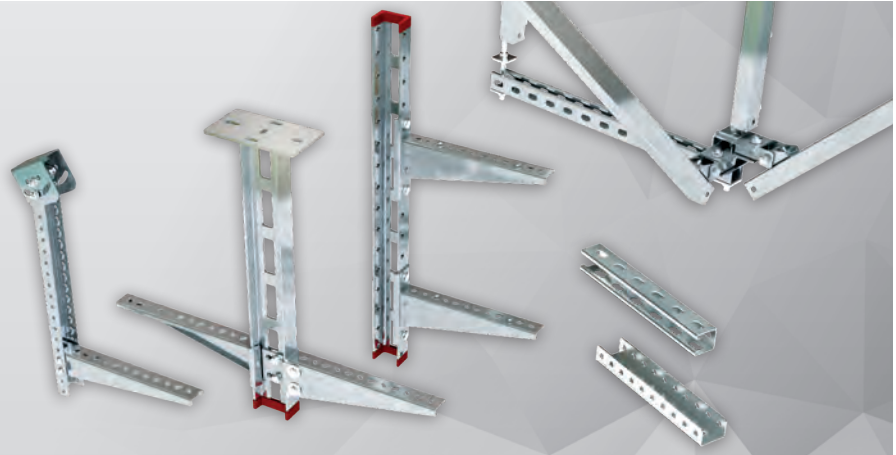

Features:

- Certified seismic suspension range
- Light service-type and heavy service-type suspension types
- Produced with a wall thickness of 2 mm to 6 mm. (Only AT3 and KT types are produced with 1.5 mm thickness)
- Pre-galvanized and hot-dip alternatives
- Hot-dip production in all welded supports
- Load deflection graphs where carrying capacities of all supports are shown
- Plating which is durable against 400-hour salt test to avoid corrosion of consumable connection elements such as rod, bolt, nut, etc
- Customized support production
- Supports with fire resistance certificate (E30, E60, E90)



▶ A-A SUPPORT SYSTEMS

Hot Dip Galvanized (TS EN ISO 1461), Fire Resistant (E30-E90)

E-Line A-A series of support systems are designed for heavy duty loads.

The A-A series can be produced from 2.0mm upto 4 mm. as bellow available finishes. With its special coating it can provide project required corrosion protection and it is fire resistant.



▶ STRUT CHANNEL (G PROFILE)

Pre-galvanized (TS EN 10346 - TS EN 10143), Hot Dip Galvanized (TS EN ISO 1461) and Stainless Steel

E-Line STRUT CHANNEL series are a modular support system especially designed for heavy duty loads with its numerous of assembly variations. The BINRAK series can be produced with 1.5, 2.0mm and 2.5mm thickness as pregalvanized and hot dip galvanized and stainless steel.



▶ SEISMIC

Hot Dip Galvanized (TS EN ISO 1461)

E-Line Seismic bracing assembly systems are designed to secure the support systems sustainability against seismic waves with lateral and longitudinal applications withstanding the push and pulling forces. The assemblies are produced as hot dip galvanized with electrogalvanized accessories.



▶ M-FIX ELECTRO-MECHANICAL SUPPORT AND SUSPENSION SYSTEMS

Pre-galvanized (TS EN 10346 - TS EN 10143) and Hot Dip Galvanized (TS EN ISO 1461)

- Pre-galvanized and Hot-Dipping alternatives
- Suspension system varieties of Light, Medium and Heavy-Duty type
- Coating resistant to salt test of 400 hours for the purpose of corrosion prevention of products such as Stem Bar, Bolt and Nuts of switch material fittings
- Mechanical suspension solutions specific to customer requirements.

▶▶ DABLINE

Raised Floor Power Distribution Systems 63-80A

Overview

DABLINE busbar systems, which has different colour options, is used for raised floor applications in offices.

Does not require cable duct, cable, junction and connector. Manufactured in either 63A or 80A current rated versions with tap off plugs rated 13A to 32A.

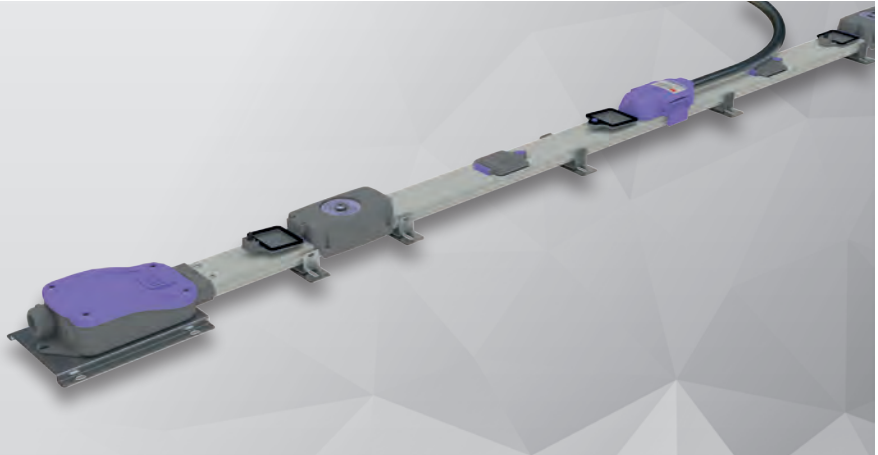

Features:

- IP55 protection degree
- Plug-in points every 30 or 60 cm.
- Each busbar length is equipped with integral adjustable fixing brackets.
- Ultra slim structure and horizontal utilization properties
- Can be used comfortably beneath a 10 cm raised floor

▶▶ E-LINE N-DK

Modular and Compact Solutions for Underfloor and Raised Floor

Overview

Stylish, safe and innovative design, modular and compact solutions.

The underfloor and raised floor power distribution systems that save office etc environments from cable stacks and offer streamlined cabling. Can be adapted when offices or work places are moved around or capacity increases.



Features:

- Socket box options with 3, 8, 16 or 24 module capacity
- Compliant with circuit protection elements such as MCB, RCD and RCBO

▶▶ E-LINE SMART

Socket Blocks Fit For Fitting-Safe, Reliable, Efficient Solutions

Overview

Products ensure high ease of use, depending on your personal needs and preferences with modular type power and low voltage sockets. Products are 7 different types, according to size in socket needs, universal and modular design makes it suitable to accept any brand of socket.



Features:

- Modular structure for energy and low voltage sockets
- 8, 10, 12, 14, 16 and 18 modules standard production capacity options
- Compatible structure with offices, meeting rooms, every desk
- Aluminum body and polycarbonate covers

▶▶ E-LINE MINI

Mini Series Pop-up and IP66 Outlet Boxes

Overview

New, aesthetic, compact and mini-solutions for working desks, raised floor and under-screed sockets...

Three different range of product with IP40 and IP66 options.

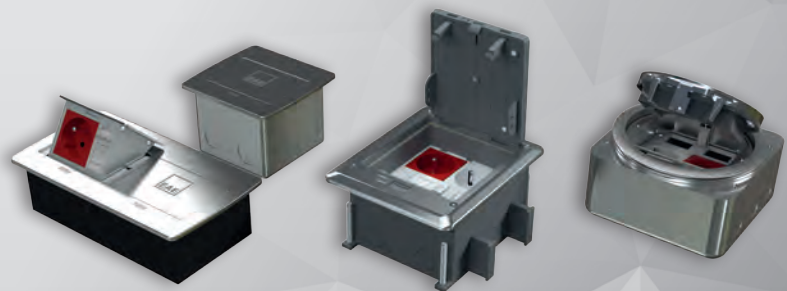

Features:

- IP40 protection degree 3 modules and 6 modules pop-up series options,
- Can be used in tabletop, under screed or raised floor applications,
- IP66 protection degree rectangle or circle options,
- Water and dust-proof
- Can be used in under screed or raised floor applications,
- Two stage opening cover

▶▶ ELINE E-BOX

Socket Combination Box

Overview

The E-BOX SOCKET COMBINATION BOX series is designed for use in factories, construction sites, workshops, and work environments. It combines sockets and functions as an electrical installation box for circuit protection and distribution...



Features:

- IP42 Protection Class
- The plastic frame material of the product is PA6, halogen-free, and meets the UL94 standard with a V2 fire resistance rating
- Operating voltage of 230/400V AC
- Various configuration options are available, with a maximum current rating of 63A
- It is suitable for mounting 16A, 240V socket type panels (Schuko) and 63A, 415V CEE standard socket type industrial plugs
- It includes a compartment with 11 modules for miniature circuit breakers (MCB) and/or residual current devices (RCD), featuring breakable plates, a padlock attachment, and a transparent cover

▶▶ E-LINE KY

Lighting & Low Power Distribution System 25-40-63A

Overview

KY Busbar System is suitable for all kinds of lighting, sockets and low power circuits with 25-40-63A current levels. Also within the scope of lighting automation, DALI and DIM circuits can be used to transmit the emergency lighting kit reference voltage.



Features:

- 3 and 4 meters standard busbar length, plug-in points every 1 meter,
- At all joint and plug-in points, the contacts are plated with silver,
- Copper conductors are covered with full length tin and copper oxide formation is prevented,
- Simple joint structure that prevents deflection and stretching.

▶▶ LED LIGHTING SOLUTIONS

Lighting has a considerable influence on our sense of wellbeing. Light is not only vital for vision; it also affects our emotions and other biological processes such as our sleep/wake rhythm.

Ambience and sense of wellbeing play a major role here – and are particularly influenced by factors such as modern design and agreeable lighting.

Warm tone lighting has a soothing effect, helps quell patient fears and thus makes for a greater sense of wellbeing in the ward. "Cold" high tech plays a less and less visible role in the day-to-day life of a hospital; the design of patient rooms is becoming more homely.

By stabilising hospital patients' and circadian rhythm, biologically effective light can set in motion a positive spiral that significantly improves cognitive abilities and emotional state by ensuring a good night's sleep and an active day. EAE Lighting luminaires can be adjusted for Human Centric Lighting applications.



HCL
available

Human Centric Lighting is a system solution which works based on changing colour temperature, luminous intensity by time according a scenario, in harmony with the Sun's changing light in a day



▶ PATIENT ROOMS

With homely, well furnished patient rooms, a service-oriented hospital can make a positive lasting impression. Good – and above all variable – lighting is needed here to help it compete for "clients" from a position of strength.

NETA **HCL**
available



FLEXBAR **HCL**
available



BIENA **HCL**
available



▶ POLYCLINICS - CORRIDORS & WAITING AREAS

The right lighting atmosphere can soothe and relax patients, especially in stress situations, e.g. before examinations, surgery or notification of examination results. Harmonious lighting has a positive effect on patients and can influence their condition.

DOWNLED



PUFFIN **HCL**
available



STL **HCL**
available



▶ POLYCLINICS - EXAMINATION ROOMS

An examination room needs to fulfil a wide variety of functions and often doubles as an office, treatment room and patient consulting room. To meet the relevant requirements, the lighting thus needs to be readily and flexibly adjustable.

STL **HCL**
available



BLOOM **HCL**
available



DOWNLED



▶▶ **UV LED LIGHTING SOLUTIONS FOR DISINFECTION**

We're all at risk of contracting or spreading viruses and bacteria, but none more so than vulnerable patients who are being cared for in hospital and healthcare settings, because any form of viral infection can complicate their recovery. UV-C luminaires don't treat people directly, they can make a difference by helping neutralize viruses and bacteria that might present a danger. All bacteria and viruses tested to date (many hundreds over the years, including various coronaviruses), respond to UV-C disinfection.



Ultra-Violet (UV) light is invisible to the human eye and is divided into UV-A, UV-B and UV-C.



▶ **OPERATING ROOMS**

During operations, surgical teams face very high mental and physical challenges. Reliability and functionality have top priority here. To permit reliable performance of the difficult visual tasks involved in what are often life and death procedures, optimal lighting is essential.

BLOOM IP65



BLOOM UVA

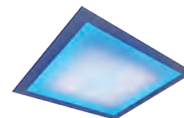

UVC Disinfection mobile machine



▶ **INTENSIVE CARE UNITS**

In rooms used for intensive care, the primary purpose of lighting is to support the treatment and monitoring of severely ill patients. First and foremost it needs to be functional, but it should still permit a homely lighting atmosphere to calm patients and help them make a swift recovery.

BLOOM IP65



BLOOM UVA

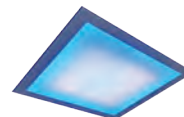

UVC Disinfection mobile machine



▶ **ANCILLARY ROOMS & OUTDOOR LIGHTING**

The ancillary rooms and outdoor facilities of a hospital require special lighting solutions. From the facade that makes the first impression to the room where nurses take a break - everything needs to be effectively and functionally illuminated as well as energy efficient and low-maintenance.

LINE ETANJ



PUFFIN



HCL available

RA



▶▶ PANELMASTER

Type-tested LV Switchgears Up to 6800A

PanelMaster low voltage switchboards are designed to fulfil various application needs. It's unique structure and flexible power modules are type-tested and certified by internationally accepted independent laboratories.

PanelMaster has been type-tested with switchgear equipment of various suppliers. This gives freedom at component selection among widely accepted and known switchgear equipment brands.



Rated Current (I_n)	: Up to 6800A
Rated Short Time Withstand Current (I_{cw})	: Up to 120 kA - 1sec.
Rated Impulse Withstand Voltage (U_{imp})	: Up to 12 kV
Partitioning	: Up to Form 4b
Protection Class	: Up to IP55
Protection Class Against Mechanical Impact	: IK10
Framework	: Painted 2mm pre-galvanized steel
Colour	: RAL 7035 epoxy-polyester electrostatic powder paint

▶▶ EAE Data Center Rack Cabinet & Containment Solutions

EAE KabinPLUS KD 19" Data Center Rack Cabinets have been designed to reach high flexibility and efficiency with a robust core construction. While providing a comprehensive approach for the cabling accessories to serve high density structured cabling, EAE KabinPLUS series offer highly versatile *Data Center Aisle and Containment Solutions* to increase the "Energy Efficiency" and manage the "Physical Security & Access Control" in data center environments.

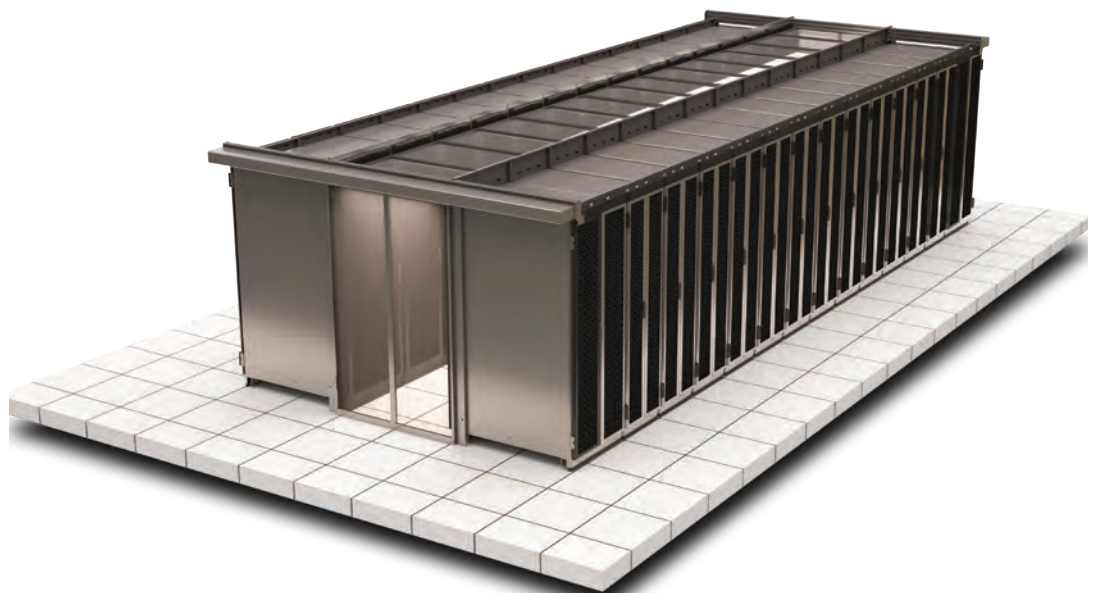

▶▶ EAE Technology Hospital Building Management Systems

The system not only helps to improve the hospital management, also enhance staff's efficiency, saving operating costs and creating safe healthcare environment.



Corridor Sensor



DALI Gateways



Presence / Movement Sensors



Switching Actuators



Fan Coil Actuator

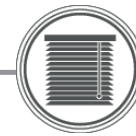

▶▶ KNX Hospital Solution

BMS Integration

- Nurse Call System Integration

Lighting Control

- DALI
- On/Off
- 1-10V
- Universal DIM (phase cut)
- Emergency Lighting Reporting

Heating-Cooling Control

- Fancoil
- VRF/VRV Control
- Under Floor Heating
- Split AC Units
- Package Air Conditioning Systems

Shutter/Blind Control

- AC/DC Blind Control

Presence / Movement / Corridor & Daylight Sensor

Group Control

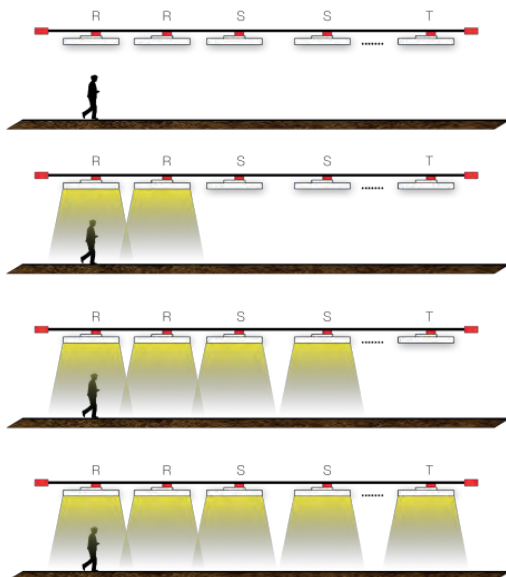

• Maxima Hospital, Eindhoven	NETHERLANDS	FAR EAST	
• Beatrix Hospital, Winterswijk	NETHERLANDS	• Rama Bangplee Hospital	THAILAND
• Hospital Ruwaard Van Putten, Spijkenisse	NETHERLANDS	• Veterans General Hospital - Bangkok	THAILAND
• Diaconessen Hospital, Leiden	NETHERLANDS	• Chulalongkorn Hospital - Bangkok	THAILAND
• Rijnland Hospital, Alphen a/d Rijn	NETHERLANDS	• Thonburi 2 Hospital -Bangkok	THAILAND
• Tønsberg Hospital, Tønsberg	NORWAY	• Srinakharinwirot University Hospital-Nonthaburi	THAILAND
• LHL Hospital, Gardermoen	NORWAY	• Pinklao Hospital - Bangkok	THAILAND
• Moss Hospital, Moss	NORWAY	• Kasemrat Hospital -Bangkok	THAILAND
• Lillehammer Hospital, Lillehammer	NORWAY	• Ramathibodi Hospital - Bangkok	THAILAND
• Ullevål Hospital, Oslo	NORWAY	• Somdech Phra Pinklao Hospital - Bangkok	THAILAND
• Rikshospitalet, Oslo	NORWAY	• Queen Savang Vadhana Memorial Hospital - Chonburi	THAILAND
• Stavanger Hospital	NORWAY	• Ratchadamri Hospital - Bangkok	THAILAND
• Spital Judetean Alexandria	ROMANIA	• Thammasat University Hospital - Pathumthani	THAILAND
• Spital Victor Gomoiu Bucharest	ROMANIA	• University of Phayao Medical Center-Phayao	THAILAND
• Institutul Matei Bals Bucharest	ROMANIA	• Mae Fah Luang University - ChiangRai	THAILAND
• Spital Sfântul Spiridon Mioveni	ROMANIA	• Bangkok Hospital Surat - Surat Thani	THAILAND
• Spital Judetean Alexandria	ROMANIA	• Queen's Phramongkutklao Hospital - Bangkok	THAILAND
• Spital Victor Gomoiu Bucharest	ROMANIA	• Bangkok Brain & Bone Hospital - Bangkok	THAILAND
• Institutul Matei Bals Bucharest	ROMANIA	• Bangkok Hospital- Chiangrai	THAILAND
• Spital Sfântul Spiridon Mioveni	ROMANIA	• Maharaj Nakorn Chiang Mai Hospital-Chiangmai	THAILAND
• Östermalms Sjukhem	SWEDEN	• Bangkok-Suratthani Hospital - Surat Thani	THAILAND
• Karolinska Hospital	SWEDEN	• TPP Healthcare Hospital - Bangkok	THAILAND
• Sabbatsbergs Hospital	SWEDEN	• Seng Kang Hospital	SINGAPORE
• Blekinge Hospital, Karlskrona	SWEDEN	• National Skin Center	SINGAPORE
• Umeå UC, Hospital	SWEDEN	• Institute Of Mental Healt Hospital	SINGAPORE
• Linköpings Hospital	SWEDEN		
• Plymouth Hospitals NHS	UNITED KINGDOM	AMERICA	
• Farnborough Hospital - Kent	UNITED KINGDOM	• Clinica Alemana	CHILE
• The Lewisham Hospital NHS Trust	UNITED KINGDOM	• Clinica Indisa	CHILE
• West Middlesex Hospital - Brentford	UNITED KINGDOM		
• Sheffield Northern General Hospital	UNITED KINGDOM	RUSSIA&CIS	
• Churchill Cancer Care - Oxford	UNITED KINGDOM	• Botkinskaya Hospital - Moscow	RUSSIA
• Derriford Hospital - Plymouth	UNITED KINGDOM	• Clinic Roshal	RUSSIA
• Bupa Nuffield Hospital - Ipswich	UNITED KINGDOM	• Crimea Hospital - Kyrım	RUSSIA
• St. Barts Hospital - London	UNITED KINGDOM	• Kommunnarka Hospital - Moscow	RUSSIA
• Southern General Hospital - Glasgow	UNITED KINGDOM	• Medsi Hospital - Moscow	RUSSIA
• UCLH - London	UNITED KINGDOM	• Maternity Hospital - Nab. Chelny	RUSSIA
• Whittington Hospital - London	UNITED KINGDOM	• Semashko Hospital Moscow	RUSSIA
• Bedford General Hospital	UNITED KINGDOM	• Semashko Hospital - Simferopol	RUSSIA
• Princess Royal Hospital	UNITED KINGDOM	• MKK Skolkovo (Internat. Med. Clus.)-Moscow	RUSSIA
• Northwick Park Hospital	UNITED KINGDOM	• Ashgabat Maternity Hospital	TURKMENISTAN
• St. James's University Hospital Leeds	UNITED KINGDOM	• Cardiology Hospital	TURKMENISTAN
MIDDLE EAST		AFRICA	
• Sheikh Khalifa Hospital	UAE	• Hospital Of Uyo	NIGERIA
• Cleveland Clinic Abu Dhabi	UAE	• TDM New	MAURITIUS
• Security Forced Hospital - Makkah	S.ARABIA	• Hospital Cheikh Khalifa Ben Zaid	MOROCCO
• 300Beds General Hospital Meqat - Madinah	S.ARABIA	• Mahra Hospital, Al Marj	LIBYA
• Saudi German Hospital - Jeddah	S.ARABIA	• Aga Khan Hospital	KENYA
• 100Beds Hospital - Jumum	S.ARABIA	• Agouza Army Hospital	EGYPT
• King Fahd Armed Forced Hospital - Dhahran	S.ARABIA	• El Fath Hospital	EGYPT
• Saudi German Hospital - Dammam	S.ARABIA	• Arbaminch Hospital	ETHIOPIA
• Armed forced Hospital - Taif	S.ARABIA	• Debrebirahan Hospital	ETHIOPIA
• 200Beds Pediatric&Obstetrics Hospital - Hail	S.ARABIA	• Sudan Hospital	SUDAN
• Nurses accomodation- Dhahran	S.ARABIA		
• CMC Hospital - Riyadh	S.ARABIA	ASIA	
• Al Iman Hospital - Riyadh	S.ARABIA	• Bexim Pharma - Tongi Gazipur	BANGLADESH
• 200Beds Pediatric&Gynecology Hospital - Tabuk	S.ARABIA	• Pharma Asia (Rangs Medicine) Rajendropur	BANGLADESH
• Nurses accomodation- Wadi Dawasir	S.ARABIA	• Mayapada Kuningan Hospital	INDONESIA
• Medical College Ext. - Riyadh	S.ARABIA	• Cancer Hospital, Lucknow, UP	INDIA
• Prince Mansour Hospital - Makkah	S.ARABIA	• Saifai Hospital, Saifai, UP	INDIA
• Armed Forces Hospital-Nurses Acc.- Makkah	S.ARABIA	• District Hospital, Noida, UP	INDIA
• Dallah Hospital - Riyadh	S.ARABIA	• ILBS Hospital, Delhi	INDIA
• Royal Oman Police	OMAN	• Cancer Hospital, Nasik, Maharashtra	INDIA
• Al Fardan Medical Center	QATAR	• Currae Hospital, Nasik, Maharashtra	INDIA
• Aman Hospital	QATAR	• Cancer care Trust Hospital, Mumbai, Maharashtra	INDIA
• Quattinah Clinic	KUWAIT	• Aster Medcity, Kochi, Kerala	INDIA
• Psychiatric Hospital	KUWAIT		
• 400 Beds Basra Hospital	IRAQ		
• Kerbela 500 Beds Government Hospital	IRAQ		
• 400 Bed Teaching Hospital-Amara	IRAQ		
• 400 Bed Teaching Hospital-Hilla	IRAQ		
• RANIA Hospital	IRAQ		

HEALTHCARE

Major References List



Gelre Hospital
Zutphen - Netherlands
Bed Capacity: 320

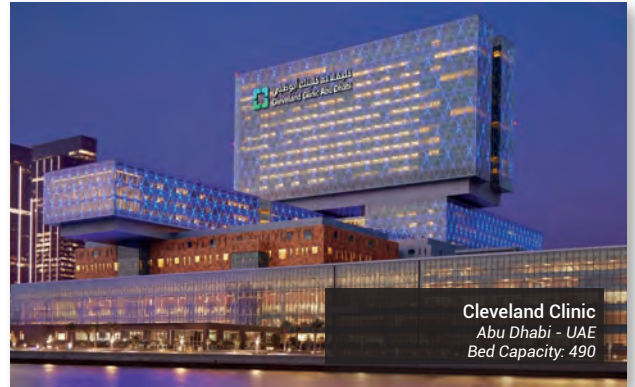

Cleveland Clinic
Abu Dhabi - UAE
Bed Capacity: 490



Royal Oman Police Hospital
Muscat - Oman
Bed Capacity: 600



Sassuolo Hospital
Sassuolo - Italy
Bed Capacity: 256



Sengkang General Hospital
Sengkang - SINGAPORE
Bed Capacity: 800



UCLH Clinical Microbiology and Virology Department
London - United Kingdom
Bed Capacity: 1161



Almoosa Specialist Hospital
Dhahran - Saudi Arabia
Bed Capacity: 240



Ankara City Hospital
Ankara - Turkey
Bed Capacity: 3704



Basic Emergency Hospital Alto Hospicio
Tarapacá - Chile
Bed Capacity: 200



CHEIKH KHALIFA BEN ZAID
Casablanca - Morocco
Bed Capacity: 205

Member List				
Serial No	Type	Pcs.		
			Company :	
			Project :	
			Project No :	
			Name :	
			Date :	
			Signature :	
			Prepared by	

Please duplicate this page for your own use.

Member List		
Serial No	Type	Pcs.

Company :	
Project :	
Project No :	
Prepared by	
Name :	
Date :	
Signature :	



Please duplicate this page for your own use.

EAE GROUP COMPANIES PRODUCT/SOLUTIONS

**BUSBAR ENERGY DISTRIBUTION SYSTEMS &
CABLE MANAGEMENT SYSTEMS &
FIT-OUT SOLUTIONS**



LIGHTING SOLUTIONS



LIGHTING AUTOMATION



**PANELMASTER ENCLOSURES /
PANELMASTER SYSTEMS**



Please visit our website for the updated version of our catalogues.
www.eaegroup.com



EAE Elektrik A.S. Head Office.

Akcaburgaz Mahallesi,
3114. Sokak, No:10 34522
Esenyurt - Istanbul - TURKEY
Tel: +90 (212) 866 20 00
Fax: +90 (212) 886 24 20
www.eaeelectric.com

EAE Lighting A.S.

Ikitelli Organize Sanayi Bolgesi
Ziya Gokalp Mahallesi,
Eski Turgut Ozal Caddesi No: 20 34490
Basaksehir - Istanbul - TURKEY
Tel: +90 (212) 413 21 00
Fax: +90 (212) 549 37 90
www.eaelighting.com

EAE Technology A.S.

Ikitelli Organize Sanayi Bolgesi
Ziya Gokalp Mahallesi,
Eski Turgut Ozal Caddesi No: 20 34490
Basaksehir - Istanbul - TURKEY
Tel: +90 (212) 413 21 00
Fax: +90 (212) 549 37 90
www.eaetechnology.com

EAE Elektroteknik A.S.

Ikitelli Organize Sanayi Bolgesi
Ziya Gokalp Mahallesi,
Eski Turgut Ozal Caddesi No: 20 34490
Basaksehir - Istanbul - TURKEY
Tel: +90 (212) 549 26 39
Fax: +90 (212) 549 37 91
www.eaeelektroteknik.com



Brochure 50-Eng. / Rev 02 1000 Pcs. 21/02/2025
N.G.

EAE has full right to make any revisions or changes on this catalogue without any prior notice.

